



The sizes are expressed in millimeters.

DESIGN DAVIDE GROPPÌ - 2005
LAMPADA A SOSPENSIONE - CARTA GIAPPONESE - PE
SUSPENSION LAMP - JAPANESE PAPER - PE

CE IP20

MOON 60 / MOON 80

CEILING ROSE

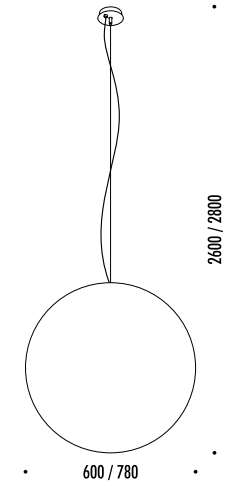
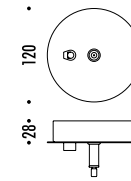

1A2820000.00.00	STANDARD - ON/OFF	MOON 60 100-240 V - 50/60 Hz - MAX 15 W LED - E27 PARALUME CON TEXTURE IN CARTA GIAPPONESE ROSONE BIANCO - CAVO BIANCO - CAVO DI SOSPENSIONE IN ACCIAIO INOX 304 ACCESSORI OPZIONALI KIT SOSPENSIONE LAMPADINA NON INCLUSA SHADE WITH JAPANESE PAPER TEXTURE WHITE CEILING ROSE - WHITE CABLE - 304 STAINLESS STEEL SUSPENSION CABLE OPTIONAL ACCESSORIES SUSPENSION KIT BULB NOT INCLUDED
1A2840000.00.00	STANDARD - ON/OFF	MOON 80 100-240 V - 50/60 Hz - MAX 15 W LED - E27 PARALUME CON TEXTURE IN CARTA GIAPPONESE ROSONE BIANCO - CAVO BIANCO - CAVO DI SOSPENSIONE IN ACCIAIO INOX 304 ACCESSORI OPZIONALI KIT SOSPENSIONE LAMPADINA NON INCLUSA SHADE WITH JAPANESE PAPER TEXTURE WHITE CEILING ROSE - WHITE CABLE - 304 STAINLESS STEEL SUSPENSION CABLE OPTIONAL ACCESSORIES SUSPENSION KIT BULB NOT INCLUDED



The sizes are expressed in millimeters.

DESIGN DAVIDE GROPPI - 2005
LAMPADA A SOSPENSIONE - CARTA GIAPPONESE - PE
SUSPENSION LAMP - JAPANESE PAPER - PE

CE IP20

CEILING ROSE

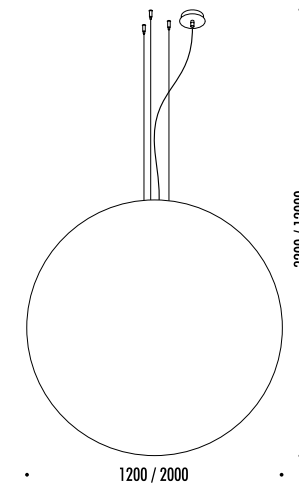
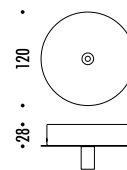







MOON 120 / MOON 200

1A2850000.00.00	STANDARD - ON/OFF	MOON 120 100-240 V - 50/60 Hz - MAX 2 x 25 W LED - E27 PARALUME CON TEXTURE IN CARTA GIAPPONESE ROSONE BIANCO - CAVO BIANCO - CAVI DI SOSPENSIONE IN ACCIAIO INOX 304 ACCESSORI OPZIONALI KIT SOSPENSIONE LAMPADINE NON INCLUSE SHADE WITH JAPANESE PAPER TEXTURE WHITE CEILING ROSE - WHITE CABLE - 304 STAINLESS STEEL SUSPENSION CABLES OPTIONAL ACCESSORIES SUSPENSION KIT BULBS NOT INCLUDED
49860010	CASSA IN LEGNO / WOODEN CRATE - MOON 120	IMBALLO PER SPEDIZIONI VIA AEREA E VIA MARE / PACKAGING FOR AIR AND SEA SHIPPING
49860020	SACCO BARRIERA / MOISTURE BARRIER BAG - MOON 120	
1A2860000.00.00	STANDARD - ON/OFF	MOON 200 100-240 V - 50/60 Hz - MAX 4 x 25 W LED - E27 PARALUME CON TEXTURE IN CARTA GIAPPONESE ROSONE BIANCO - CAVO BIANCO - CAVI DI SOSPENSIONE IN ACCIAIO INOX 304 LAMPADINE NON INCLUSE - TRASPORTO ESCLUSO SHADE WITH JAPANESE PAPER TEXTURE WHITE CEILING ROSE - WHITE CABLE - 304 STAINLESS STEEL SUSPENSION CABLES BULBS NOT INCLUDED - DELIVERY EXCLUDED
48780020	CASSA IN LEGNO / WOODEN CRATE - MOON 200	IMBALLO PER SPEDIZIONI VIA AEREA E VIA MARE / PACKAGING FOR AIR AND SEA SHIPPING
48780030	SACCO BARRIERA / MOISTURE BARRIER BAG - MOON 200	





CODE	SOCKET	TENSION	WATTAGE	BEAM ANGLE (°)	TEMPERATURE (K)	SOURCE LUMENS	BULB EFFICIENCY	CRI (Ra)	DIMMABLE	PRODUCT REFERENCE
------	--------	---------	---------	----------------	-----------------	---------------	-----------------	----------	----------	-------------------

LAMPADINE LED / LED BULBS

	50330500	GU10	220-240 V	5,5 W	25°	3000K	375 lm	G	97	X	DOT P 51 DOT P DE 51 DOT PL 51 DOT R 51 DOT SISTEMA 51 MINI 51 MINI BIT 51 MINI PL 51 MOON 60 DE TRICK TRACK
	50330740	GU10	220-240 V	4,9 W	120°	3000K	550 lm	E	80	-	Q
	50330450	GU4	12 V	20 W	24°	2700K	200 lm	G	80	-	OVO OVONELPIATTO
	50330530	GU5,3	12 V	6,7 W	36°	3000K	440 lm	G	97	X	BUCO R
	50041410	E14	220-240 V	4,5 W	-	2700K	470 lm	F	>80	X	PALPEBRA
	52080010	E27	220-240 V	7 W	360°	2700K	806 lm	E	80	X	ABA 45 ABA 120 EDI SON
	50330790	E27	220-240 V	11,2 W	360°	2700K	1521 lm	D	90	X	MOON 60 MOON 60 DE MOON 80 MOON 200 MOON T SHOJI
	50330650	E27	220-240 V	13 W	200°	2700K	1521 lm	E	80	-	LENTA SHOJI OUTDOOR
	50041470	E27	220-240 V	21 W	200°	2700K	2452 lm	E	>80	X	MOON 120
	50330730	E27	220-240 V	9,5 W	25°	3000K	760 lm	F	80	X	CHILLOUT NEURO

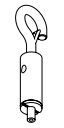
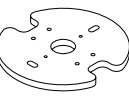
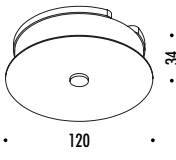

ACCESSORI OPZIONALI / OPTIONAL ACCESSORIES

1A0510000.00.00	STANDARD	KIT FISSAGGIO PER SOFFITTO INCLINATO - NICHELATO 1 PEZZO SLOPED CEILING FIXING KIT - NICKEL PLATED - 1 PIECE	
		COMPATIBLE LAMPS: QuiQuoQua - MASAI - FOSBURY - MOON 120 - SPY - SPY DE	
1A0520000.00.00	STANDARD	KIT FISSAGGIO PER ROSONE INCLINATO - NICHELATO 1 PEZZO SLOPED ROSE FIXING KIT - NICKEL PLATED - 1 PIECE	
		COMPATIBLE LAMPS: MOON 60 - MOON 60 DE - MOON 80	
1A0530000.00.00	STANDARD	GANCIO PER SOFFITTO INCLINATO - CROMATO 1 PEZZO SLOPED CEILING FIXING HOOK - CHROME PLATED - 1 PIECE	
		COMPATIBLE LAMPS: SIMBIOSI - SHANGHAI	
1A0360000.00.00	STANDARD	KIT DECENTRATORE / DECENTRALIZATION KIT	
		COMPATIBLE LAMPS: LED IS MORE - MISS 1 - MOON 60 - MOON 60 DE MOON 80 - MOON 120 - CATHODE 1	
1A0770300.00.00	BIANCO OPACO / MATT WHITE	KIT ROSONE + DECENTRATORE KIT CEILING ROSE + DECENTRALIZER CAVO BIANCO 3 m INCLUSO WHITE CABLE 3 m INCLUDED	
1A0770400.00.00	NERO OPACO / MATT BLACK	KIT ROSONE + DECENTRATORE KIT CEILING ROSE + DECENTRALIZER CAVO NERO 3 m INCLUSO BLACK CABLE 3 m INCLUDED	
1A3270300.00.00	BIANCO OPACO / MATT WHITE	BLOCCACAVO - 1 PEZZO CLAMP - 1 PIECE	
1A3270400.00.00	NERO OPACO / MATT BLACK		

1A051000.00.00 - KIT FISSAGGIO PER SOFFITTO INCLINATO / SLOPED CEILING FIXING KIT

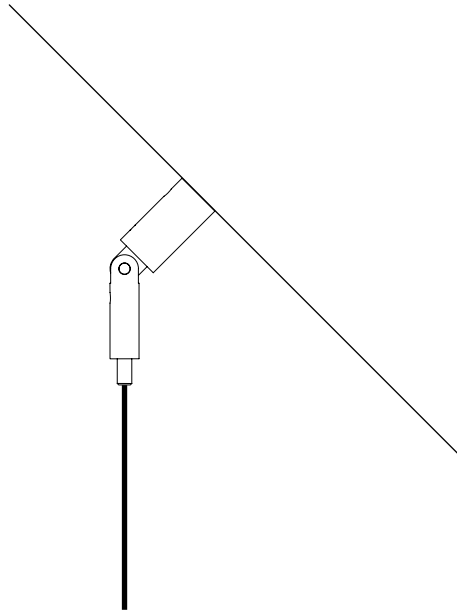

1A052000.00.00 - KIT FISSAGGIO PER ROSONE INCLINATO / SLOPED ROSE FIXING KIT

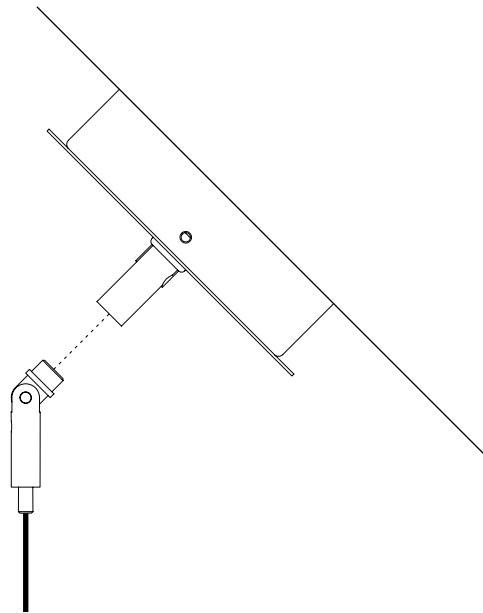

1A053000.00.00 - GANCIO PER SOFFITTO INCLINATO / SLOPED CEILING FIXING HOOK

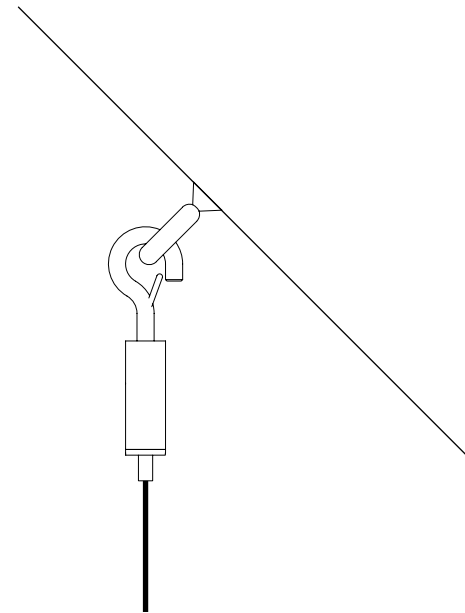

1A0770300.00.00 / 1A0770400.00.00 - KIT ROSONE + DECENTRATORE / KIT CEILING ROSE + DECENTRALIZER | 1A0360000.00.00 KIT DECENTRATORE / DECENTRALIZATION KIT

